

# Agilent Signal Studio for *Bluetooth*<sup>™</sup> E4438C ESG Vector Signal Generator

Option 406

Application Note 1421

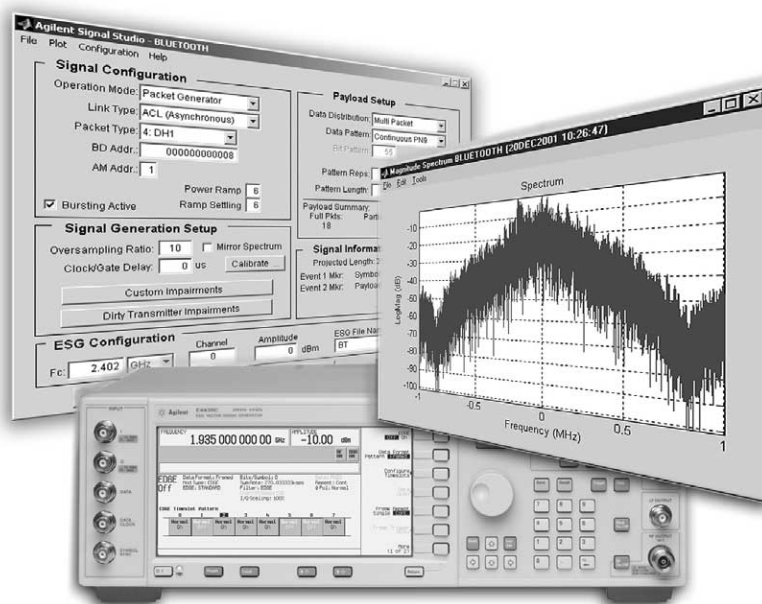

## ***Use Signal Studio to Create Bluetooth Test Signals***

Signal Studio for *Bluetooth* software is a powerful tool for creating *Bluetooth* baseband I/Q waveforms for use with the Agilent E4438C ESG vector signal generator. Select from thirteen different packet types to configure, download and store the waveforms in the ESG, and use the ESG flexible waveform sequencer to generate custom packet sequences.

## **E4438C ESG vector signal generator main features**

- 250 kHz to 1, 2, 3, 4, or 6 GHz frequency range
- Up to 64 megasamples (MSa) waveform playback memory
- Up to 6 GB non-volatile waveform storage
- Single-ended and differential I/Q outputs
- LAN and GPIB connectivity

## **Signal Studio for *Bluetooth* main features:**

- Intuitive user interface
- Fully coded *Bluetooth* packets and *Bluetooth* modulated data streams
- Packet types: DH1, DH3, DH5, DM1, DM3, DM5, AUX1, HV1, HV2, HV3, NULL, POLL, ID
- Standards-based dirty transmitter setup for receiver sensitivity tests
- Custom impairments: sinusoidal & linear frequency drift, frequency offset, symbol timing error, modulation index, AWGN
- Simplifies BER testing
- Plot BER vs. clock/gate delay
- Plot the I/Q signals and spectrum of the configured baseband waveform



**Agilent Technologies**

## Table of Contents

This application note is a self-guided tutorial describing the test signals that can be created with the Signal Studio for *Bluetooth* software. This document is not meant to be a *Bluetooth* technology tutorial. Basic knowledge of the *Bluetooth* radio specification is required. For additional information on *Bluetooth* technology, refer to the *References* section at the end of this document.

---

Software Overview .....	2
Ease of Use .....	3
Signal Structure .....	4
<i>Bluetooth</i> modulation and transmission parameters .....	4
<i>Bluetooth</i> transmission scheme .....	4
<i>Bluetooth</i> link types .....	5
<i>Bluetooth</i> packets .....	5
Connecting to the ESG .....	6
Creating Signals .....	6
Step 1 - Configure the <i>Bluetooth</i> signal .....	6
Step 2 - Setup the signal generation parameters .....	15
Step 3 - Configure the ESG .....	30
Step 4 - Calculate and download .....	32
Basic Measurements .....	35
Receiver measurements .....	35
ESG BER analysis capability .....	35
BER measurements setup .....	36
BER measurements example – clock/gate delay calibration .....	38
Signal Studio for <i>Bluetooth</i> Features .....	42
Acronym List .....	44
Additional Literature .....	45
References .....	45
Appendix .....	46
Recommended Configuration .....	47

---

## Software Overview

The Signal Studio for *Bluetooth* software is an intuitive Windows®-based tool for configuring *Bluetooth* packets and *Bluetooth* modulated data streams. The software calculates an I/Q waveform file based on the *Bluetooth* signal configuration parameters set by the user. Most waveforms take only a few seconds to build. The waveform file can then be downloaded to the ESG internal baseband generator for playback in arbitrary waveform mode.

In addition to creating waveform files, the software provides configuration menus for key signal generator settings, including frequency and amplitude. The instrument settings, along with the I/Q waveform file, are passed to the ESG over the LAN or GPIB interface.

After downloading the waveform file and instrument settings to the signal generator, it automatically begins generating the *Bluetooth* modulated RF signal. Local control of the signal generator is then re-enabled and instrument settings, like frequency and amplitude, can be modified from the ESG front panel. The waveform files cannot be modified once they have been downloaded to the instrument.

The waveform files can be saved in the ESG non-volatile memory and recalled for playback at any time. In addition, the Signal Studio software configuration can be saved to the host computer's local hard drive and recalled at any time to re-calculate and download the waveform to the signal generator for playback.

## ***Ease of Use***

Signal Studio simplifies creating *Bluetooth* test signals for use with ESG. Rather than spending valuable time coding *Bluetooth* packets at the bit level, use the software to create fully coded, standard-based *Bluetooth* packets and *Bluetooth* modulated data streams.

### **Intuitive user interface**

Signals can be rapidly configured in an easy-to-use graphical software environment.

### **Thirteen fully coded *Bluetooth* packet types**

The software provides 13 different *Bluetooth* packet types to configure, including both voice and data packets. Because these packets are fully coded, demodulation and decoding capabilities of the DUT can be tested.

### ***Bluetooth* modulated data streams**

Continuous, non-bursted, non-packetized *Bluetooth* modulated data streams can be configured using the software. These signals are ideal for generating *Bluetooth* interference signals and basic test signals that do not require decoding to perform BER analysis.

### **Add signal impairments**

Create standards-based dirty transmitter or custom impaired test signals. Simulate a realistic *Bluetooth* device signal by adding frequency, modulation, and noise impairments to the signal when performing receiver tests.

### **Waveform sequencing**

Take advantage of the ESG waveform playback memory (8 or 64 MSa) to playback longer waveforms or create custom packet sequences. The Signal Studio for *Bluetooth* software and the ESG built-in waveform sequencing capability combine to provide flexible generation of custom *Bluetooth* packet sequences.

### **Baseband and RF signals**

Use the ESG single-ended and differential I/Q outputs to inject baseband signals in the transmit or receive paths of the device under test. Or drive the DUT using the ESG RF port tuned to the IF or carrier frequency of interest.

### **Simplified BER analysis**

To facilitate receiver BER measurements on *Bluetooth* devices, an automated clock/gate delay calibration utility is provided in the software. Using the utility, the data, clock, and gate signal timing alignment at the input of the ESG internal BER analyzer can be easily determined and modified to attain accurate results.

---

## Signal Structure

This section provides a quick review of key *Bluetooth* signal characteristics. Additional information about the *Bluetooth* signal structure can be found in the *Bluetooth System Specification*.

---

### Bluetooth modulation and transmission parameters

---

#### Modulation parameters

Modulation type	FSK – frequency shift keying
Baseband filtering	Gaussian, BT = 0.5
Maximum frequency deviation	140 – 175 kHz
Modulation index	0.28 – 0.35
Symbol rate	1 Msymbol/second

---

#### Transmission parameters

Frequency band	2.4 GHz ISM band
Transmission scheme	TDD – time division duplex
Spreading type	FHSS – frequency hopping spread spectrum
Number of channels	79
Channel spacing	1 MHz [(f = 2.402 + k) GHz, k = 0,1,2,...78]
Hop rate	1600 hops/second

---

### Bluetooth transmission scheme

---

#### Time-division duplex

In *Bluetooth* systems, master and slave devices exchange information by alternating packet transmissions in time-division duplex, Figure 1. The master starts its transmission in even-numbered time slots only, and the slave starts its transmission in odd-numbered timeslots only.

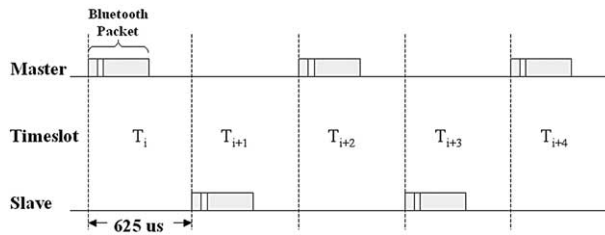

Figure 1. *Bluetooth* time-division duplex transmission scheme.

#### Frequency hopping

In normal operation, *Bluetooth* devices typically hop to a new carrier frequency each timeslot. However, when performing the majority of transmitter and receiver tests as indicated in the *Bluetooth* RF Test Specification, frequency hopping is disabled.

---

## Signal Structure

### Bluetooth link types

---

Two types of links can be established between *Bluetooth* devices:

#### *Asynchronous Connection-Less (ACL) link*

The ACL link is a point-to-multipoint link between the master and all slaves participating on the piconet. It is considered a packet-switched connection primarily intended for transmitting non-time sensitive information, like data. The fundamental packet length in *Bluetooth* systems occupies a single timeslot, as shown in Figure 1. Packets that occupy multiple timeslots are used to achieve increased data rates on the ACL link because they have larger payload fields.

#### *Synchronous Connection-Oriented (SCO) link*

The SCO link is a point-to-point link between the master and a single slave. It is considered a circuit-switched connection primarily intended for transmitting time sensitive information, like voice. All SCO link packets occupy a single timeslot; however, the packet transmission rate varies depending upon how much voice information is carried in the packet payload. The objective is to maintain a 64 kb/s link for voice transmission. However, because of the overhead associated with FEC coding, packets with FEC on the speech data must be transmitted at a faster rate than packets with no FEC to achieve an equivalent speech data rate (64 kb/s).

---

### Bluetooth packets

---

#### *Packet types*

There are many different types of packets used to exchange information on a *Bluetooth* link. They can be generally categorized into three groups:

1. ACL link packets
2. SCO link packets
3. Control packets

#### *Packet structure*

All *Bluetooth* packet types are constructed based upon a standard packet structure, Figure 2. The standard packet structure consists of three fields: access code, header, and payload. In general, the access code and header fields carry overhead information necessary to communicate over a *Bluetooth* link and the payload field carries the user data to be exchanged. The amount of information contained within the payload field and degree of forward error correction (FEC) changes significantly depending upon the packet type.

Access code 72 bits	Header 54 bits	Payload 0 to 2744 bits
------------------------	-------------------	---------------------------

**Figure 2. Standard *Bluetooth* packet structure.**

Signal Studio software supports 13 different packet types, including both synchronous and asynchronous link type packets. The *Creating signals* section of this document provides additional detail about the structure of these packets and explains how to configure them using Signal Studio.

---

## Connecting to the ESG

The Signal Studio software must be installed in a host computer prior to creating *Bluetooth* test signals. Before attempting to download waveforms to the instrument, verify that the host PC is communicating with the ESG. For additional information on connecting to the signal generator, refer to the *E4438C Signal Studio Installation Guide*, available on the website: [www.agilent.com/find/signalstudio](http://www.agilent.com/find/signalstudio).

## Creating Signals

This section describes how to configure and download *Bluetooth* signals to the ESG using the Signal Studio software. There are four basic steps:

- Step 1 - Configure the *Bluetooth* signal
- Step 2 - Set up the signal generation parameters
- Step 3 - Configure the ESG
- Step 4 - Calculate and download

### Step 1 Configure the *Bluetooth* signal

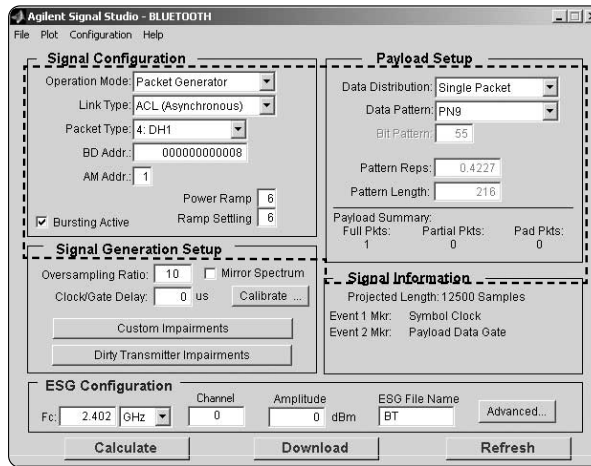

Figure 3. Signal Configuration and Payload Setup menus.

The Signal Configuration and Payload Setup menus provide an intuitive interface for constructing *Bluetooth* modulated data streams and fully coded *Bluetooth* packets, Figure 3. To distinguish the type of signal select a mode from the **Operation Mode** pull-down menu, provided in the Signal Configuration menu, Figure 4. Two modes of operation are available to choose from: Data Stream and Packet Generator.

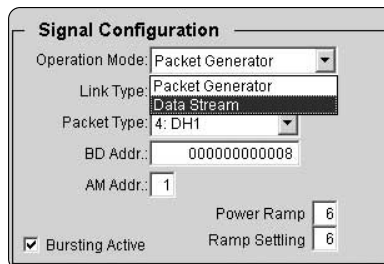

Figure 4. Operation Mode pull-down menu.

[www.agilent.com/find/esg](http://www.agilent.com/find/esg)

## Creating Signals

### Data stream mode

When operating in data stream mode, a waveform comprised of a continuous non-bursted stream of data can be configured. This type of waveform is typically used as an interference signal or a basic test signal that doesn't require decoding to perform BER analysis. The signal configuration and Payload Setup menu parameters used to configure *Bluetooth* packet structures (link type, packet type, device address, etc.) are disabled in data stream operating mode. Only fields necessary to configure a non-bursted raw data stream can be modified.

To configure the data stream, select the desired data pattern in the Payload Setup menu. The length of the data stream can be defined by either setting the number of bits in the length field or setting the number of times the pattern is repeated in Repetitions field.

The screenshot shows two panels: 'Signal Configuration' and 'Payload Setup'.  
**Signal Configuration:**  
- Operation Mode: Data Stream (dropdown)  
- Link Type: ACL (Asynchronous) (dropdown)  
- Packet Type: N/A (dropdown)  
- BD Addr.: 000000000008 (text field)  
- AM Addr.: 1 (text field)  
- Power Ramp: 6 (text field)  
- Ramp Settling: 6 (text field)  
-  Bursting Active (checkbox)

**Payload Setup:**  
- Data Distribution: Single Packet (dropdown)  
- Data Pattern: PN15 (dropdown)  
- Bit Pattern: 55 (text field)  
- Pattern Reps.: 1 (text field)  
- Pattern Length: 32767 (text field)  
**Payload Summary:**  
- Full Pkts: N/A  
- Partial Pkts: N/A  
- Pad Pkts: N/A

**Figure 5. Setup for continuous PN15 *Bluetooth* modulated interference signal.**

For example, to configure a continuous PN15 *Bluetooth* modulated interference signal, select PN15 in the data pattern pull-down menu and enter 1 in the pattern repetition field, Figure 5. Alternatively, 32767 could have been entered into the length field. When the repetitions field is modified, the length field is automatically updated, and vice versa. When downloaded to the ESG, the baseband generator will continuously repeat this data pattern during waveform playback.

## Creating Signals

### User file format

Both modes of operation, Data Stream and Packet Generator, allow users to select **User File** as the Data Pattern. This data must be in binary form. The most significant bit (MSB) of the first byte in the user data file will be the first bit of the user payload. The MSB of the second byte in the user file will be the ninth bit of the user payload, and so on. An example MATLAB® program to generate and save user data is included in the appendix section of this document.

### User File

If User File is selected as the data pattern, the number of bits in the user's data file will equal the value displayed in the Pattern Length field, when the Pattern Reps field is set to one. The number of times the pattern is repeated can be selected by entering the desired repetition value in the Pattern Reps field. The Pattern Reps and Pattern Length fields are coupled. If one of these fields is changed, the other field will automatically be updated.

### Packet generator mode

When operating in Packet Generator mode, the software creates fully coded, standard-based *Bluetooth* packets. Table 1 provides a summary of the different packets that can be configured using the software.

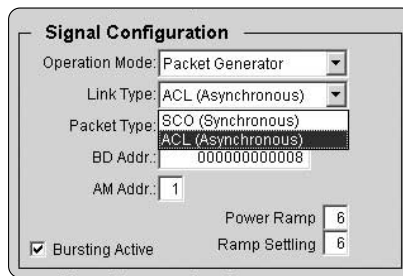

The image shows a 'Signal Configuration' dialog box with the following fields and values:

- Operation Mode: Packet Generator
- Link Type: ACL (Asynchronous) (This field is expanded to show a list with 'ACL (Asynchronous)' selected)
- Packet Type: SCO (Synchronous)
- BD Addr.: 000000000008
- AM Addr.: 1
- Power Ramp: 6
- Ramp Setting: 6
- Bursting Active:

Figure 6. Link Type pull-down menu.



## Creating Signals

To configure a packet, first set the Link Type pull-down menu to ACL or SCO, Figure 6. Then select the desired packet in the packet type pull-down menu. A different set of packets is available to choose from in the packet type pull-down menu depending on which link type is selected, see Table 1. Control packets are always available because they are common to both link types.

Packet	Type			Code (b <sub>3</sub> b <sub>2</sub> b <sub>1</sub> b <sub>0</sub> )	Description	Length (Slot)
	ACL	SCO	Control			
DH1	•			0100	High data rate packet	1
DH3	•			1011	High data rate packet	3
DH5	•			1111	High data rate packet	5
DM1	•	•		0011	Medium data rate packet	1
DM3	•			1010	Medium data rate packet	3
DM5	•			1110	Medium data rate packet	5
AUX1	•			1001	Auxiliary packet	1
HV1		•		0101	High quality voice packet	1
HV2		•		0110	High quality voice packet	1
HV3		•		0111	High quality voice packet	1
NULL			•	0000	Null packet	1
POLL			•	0001	Poll packet	1
ID			•	n/a	Identification packet	1

**Table 1. Summary of packet types that can be configured using Signal Studio for Bluetooth.**

### ACL and SCO packets

The Signal Studio software performs all the necessary coding to create the selected packet type; including forward error correction (FEC) and cyclic redundancy check (CRC) for the header and payload fields when required. As a result, the process for configuring the different ACL and SCO packets is very similar. Only a few basic parameters need to be set so that the access code, header, and payload fields of the Bluetooth packet can be created.

#### Access code

The access code field is created based on the user-defined Bluetooth Device Address (BD ADDR). The BD ADDR is a unique 48-bit device address allocated to each Bluetooth transceiver. To configure the BD ADDR, enter a 48-bit device address in hexadecimal notation (most significant bit to least significant bit).

#### Header

The header field is created using the type code of the selected packet type and the active member address (AM ADDR) of the Bluetooth device for which the packet is intended. The AM ADDR is a 3-bit address used to distinguish between the active participating slaves on a piconet. To configure the AM ADDR, enter the 3-bit address in octal notation (most significant bit to least significant bit).

#### Payload

The structure of the payload field varies depending on which packet type is selected. Table 2 provides a summary of the payload field structure for all packet types supported by the software. Additional details regarding the packet structure can be found in the Bluetooth System Specification.

## Creating Signals

Packet	Access code field	Header field	Payload field	Payload summary			
				Header (bytes)	User data (bytes)	FEC	CRC
DH1	•	•	•	1	0 to 27	no	yes
DH3	•	•	•	2	0 to 183	no	yes
DH5	•	•	•	2	0 to 339	no	yes
DM1	•	•	•	1	0 to 17	2/3	yes
DM3	•	•	•	2	0 to 121	2/3	yes
DM5	•	•	•	2	0 to 224	2/3	yes
AUX1	•	•	•	1	0 to 29	no	no
HV1	•	•	•	n/a	10	1/3	no
HV2	•	•	•	n/a	20	2/3	no
HV3	•	•	•	n/a	30	no	no
NULL	•	•					
POLL	•	•					
ID	•						

**Table 2. Basic structure of the packets supported by Signal Studio for Bluetooth.**

The Payload Setup menu offers a variety of custom payload data configurations for single and multi packet sequences. First select whether the data pattern is to be distributed into a single packet or over a multiple packet sequence using the Data Distribution pull-down menu.

### Configuring a single packet

When Single Packet is selected, Figure 7, the software creates a waveform that consists of one *Bluetooth* packet. When downloaded to the ESG, the waveform is repeatedly played back resulting in a packet sequence comprised of identical packets.

**Figure 7. Example single packet setup.**

The payload field, for the selected packet type, is filled to capacity with the data type selected in the data pattern pull-down menu. If PN data patterns are selected, the PN sequence is truncated after the maximum amount of user data has been placed in the packet.

### User File

If User File is selected as the data pattern, the number of bits, shown in the Pattern Length field, equals the number of bits in the user data file, up to the number of bits allowed for that packet type. Any remaining bits in the user data file beyond the maximum amount will be truncated.

The Pattern Length and Pattern Reps fields are automatically updated as different packet types and data sequences are selected. However, these fields cannot be modified when Single Packet has been selected from the Data Distribution pull-down menu.

### Configuring a multiple packet sequence

When Multi Packet is selected, Figure 8, the software creates a waveform that consists of a multiple packet sequence. A data pattern is distributed into the payload portion of each packet in the sequence. Once downloaded to the instrument, the signal generator repeatedly plays back the entire packet sequence. The net result is the ability to configure longer data sequences for analysis.

## Creating Signals

Figure 8. Example multi packet sequence setup.

The data type selected in the data pattern pull-down menu is spread over the payload portion of the packet sequence, Figure 9. The length of the data stream can be defined by either setting the number of bits in the length field or the number of times the pattern is repeated in repetitions field. When either of these fields is modified, the other is automatically updated. The number of packets required to accommodate the length and repetition field setting is automatically updated in the Payload Summary section of the menu.

Figure 9. Data Pattern pull-down menu.

The payload of each packet in the sequence is filled to capacity with the selected data pattern if possible. When the length of the data pattern is selected such that it is not divisible by an integral number of packet payloads, a packet with a partial payload is generated to accommodate the remaining portion of the data pattern. This packet is then appended to the sequence of full packets.

Note: The payload portion of a *Bluetooth* packet must be filled with an integral number of data bytes (1 byte = 8 bits). If the length of the data pattern is not evenly divisible by eight bits, then zeros are appended to the selected data pattern until this criteria is met.

Two packet sequence presets, continuous PN9 and continuous PN15, are provided in the data pattern pull-down menu when multi packet is selected, Figure 9. These presets are intended to simplify the setup process when configuring a packet sequence with continuous PN data distributed over the payload portion of each packet payload. When continuous PN9 or PN15 is selected in the Data Pattern pull-down menu, the software automatically configures the Length and Repetitions fields, Figure 10. The number of packets required to accommodate the selected continuous PN pattern is also automatically determined and updated in the Payload Summary section.

## Creating Signals

Payload Summary:		
Full Pkts:	Partial Pkts:	Pad Pkts:
18	1	1

Figure 10. Payload Setup for a multi packet sequence with continuous PN9 user data.

### Payload summary section

**Full packets** – Number of packets with payload filled to capacity.

**Partial packets** – Because the payload portion of each packet is filled to capacity if possible, the number of partial packets appended to the end of a packet sequence will always be 0 or 1.

**Pad packets** – When the software creates a multiple packet sequence, the sequence bit in the header field is toggled after each packet transmission in the sequence. This indicates to the *Bluetooth* device that the incoming packet is not a re-transmitted packet. To maintain an alternating sequence bit when the waveform is repeatedly played back, an even number of packets must be generated. If the data pattern length is set such that an odd number of packets are required to send the data, then a pad packet is appended to the end of the packet sequence. The pad packet has no payload and is only generated in this circumstance to accommodate the alternating sequence bit.

### User File

If User File is selected as the Data Pattern, the bits in the user data file will be distributed across multiple packets. The payload of each packet in the sequence is filled to capacity with the user's data file, up to a maximum of 80,000 bits. The packets will contain the maximum number of bits for each packet type as long as bits are available from the user's data file. The same conditions apply to the User File as the other, multipacket Data Patterns mentioned above, except the Pattern Reps setting is fixed at 1 repetition.

### Calculating a long multiple packet sequence

If a PN15, Continuous PN15, or a User File is chosen as the data pattern, a calculation warning will appear. See Figure 11. The amount of time it takes your PC to calculate the signal depends on the PC's amount of RAM and the speed of the processor. As the amount of samples shown in the Projected Length field increases, so does the amount of time it takes the PC to calculate the signal. If the calculation takes longer than 20 minutes, it is likely that it has failed, even if an error message is not visible.

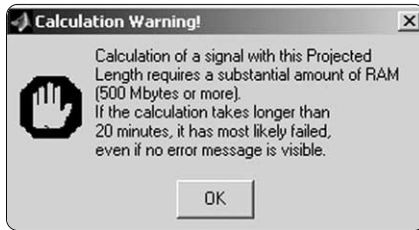

Figure 11. Calculation Warning message for multi packet generation using PN15 sequences and user files

### Control packets

As indicated in Table 2, the ID, NULL, and POLL packets do not contain a payload field. As a result, the payload setup menu is disabled when one of these packet types is selected in the packet type pull-down menu.

NULL and POLL packets are composed of an access code and header field (126-bit fixed length). When configuring NULL and POLL packets, only the BD ADDR and AM ADDR need to be set.

The ID packet is comprised of only an access code (68-bit fixed length). Because the ID packet does not contain header and payload fields, only the BD ADDR needs to be configured.

### Bursting

In Packet Generator mode, bursting can be enabled or disabled in the Signal Configuration menu, Figure 12.



Figure 12. Disable Bursting or set the Power Ramp and Settling times.

When enabled, the packet transmission timing of the test signal adheres to the *Bluetooth* TDD slot structure for the selected packet type. A summary of the transmission rates for each the packet types supported by the software is provided in Figure 13.

## Creating Signals

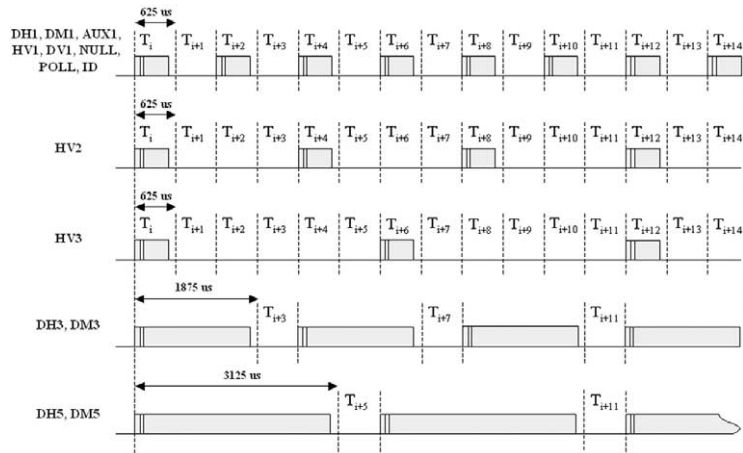

**Figure 13. Bursted transmission timing relationships for different packet types.**

At the beginning and end of a packet transmission, the ESG ramps power following a user-defined burst profile. The burst profile is defined by setting the Power Ramp and Ramp Settling fields with the desired time duration (in microseconds). See Figure 13. The ramp profile is the duration of time prior to the first symbol transmission, over which the carrier frequency is ramped from idle power to transmit power. The power ramp is shaped with a cosine function, and length of the ramp can be adjusted. The Ramp Settling field sets the length of time allowed for the power level to stabilize prior to the first symbol transmission of the first bit of the preamble,  $t_{po}$ . The settling time includes the power ramp time as indicated in the *Bluetooth* specification, see section 6.2.2 of the SIG's RF Test Specification under the "Reference Signal Definition" section. The default settings of a 6  $\mu$ s power ramp and ramp settling time produce the ramp profile shown in Figure 14.

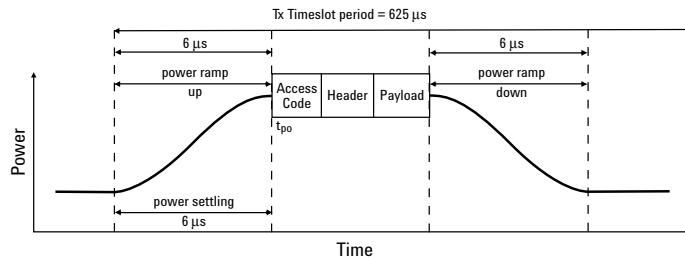

**Figure 14. Burst profile of a single slot packet transmission with 6  $\mu$ s power ramp and ramp settling.**

A reference burst profile for signal generator test signals is indicated in the *Bluetooth* RF test specification. This burst profile is recommended when performing the dirty transmitter test. The reference burst power ramp is 2  $\mu$ s and the ramp settling time is 4  $\mu$ s. This ramp profile is shown in Figure 15.

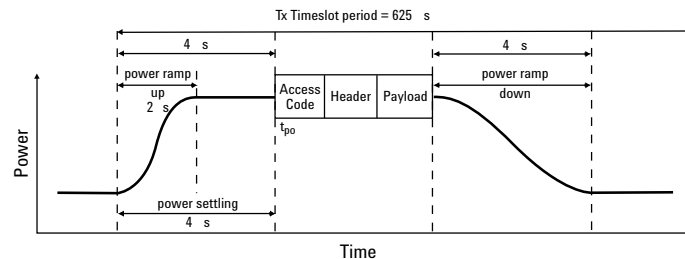

**Figure 15. Burst profile of a single slot packet transmission with 2  $\mu$ s power ramp and 4  $\mu$ s ramp settling.**

## Creating Signals

When modifying the burst profile, keep in mind that as the rise/fall time of the burst signal is decreased, the amount of spectral splatter is increased due to bursting. When bursting is disabled, the ESG transmits concatenated packets with no power ramping. The effect of disabling burst transmission is shown in Figure 16. Notice that there is no off time between packets when burst transmission is disabled. This concept can be extended to all the packet types shown in Figure 13. This non-bursted transmission structure is similar to data stream mode; however, in data stream mode there is no access code or header associated with the data transmission.

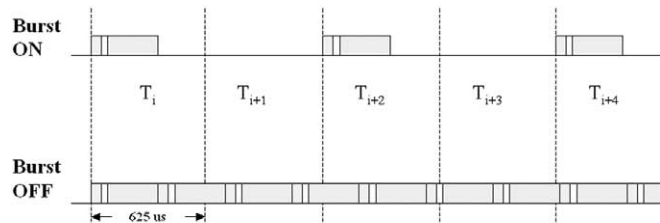

Figure 16. Bursted and non-bursted single slot packet transmission.

## Step 2 Set up the signal generation parameters

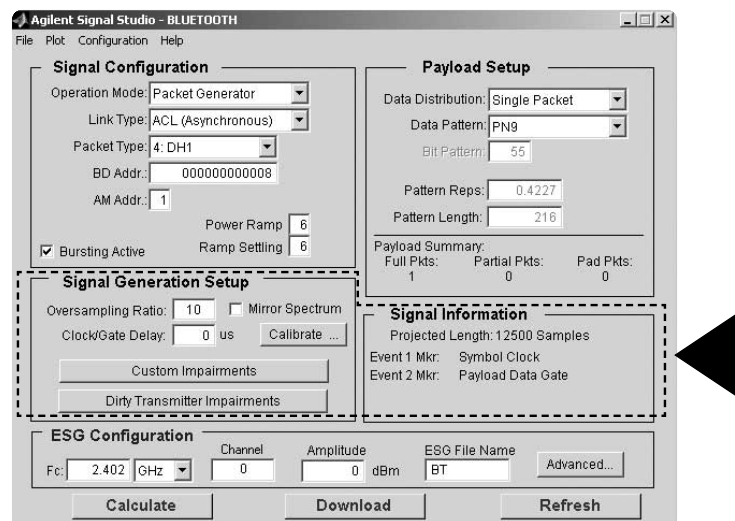

Figure 17. Signal Generation Setup and Signal Information menus.

The Signal Generation Setup menu, boxed in Figure 17, provides a simple interface for defining the oversampling ratio, mirroring the spectrum, delaying clock and gate signals, and adding signal impairments.

### Oversampling ratio

The oversampling ratio defines the number of samples calculated per I/Q symbol. Increasing the oversampling ratio of the signal increases the separation of the sampling images from the desired signal. This allows for better image rejection by the baseband reconstruction filter. However, the improved image rejection comes with a price. Increasing the oversampling ratio increases the waveform calculation time and file size. Notice that the projected file length in the signal information section is updated as the oversampling ratio setting is increased. The default setting is sufficient for most applications. Additional benefits of modifying the oversampling ratio are discussed in the *Clock/gate delay* section.

## Creating Signals

### Mirror spectrum

Enabling the mirror spectrum feature inverts the Q channel, resulting in a mirrored spectrum. As a signal normally propagates through the different functional blocks of a receiver, for example the mixer block, the signal spectrum may be reversed. Using this feature facilitates realistic testing of receiver functional blocks that would normally be presented with a mirrored spectrum signal.

### Clock and gate signals

The Signal Studio software makes use of the ESG markers to generate clock and gate signals along with the configured waveform. These signals are necessary to perform BER analysis on *Bluetooth* packets and data streams using the ESG internal BER analyzer.

A symbol clock is generated on the ESG event one port for all waveforms created using the Signal Studio for *Bluetooth* software. Because *Bluetooth* is 2-level FSK modulated (1 bit/symbol), the symbol clock can be used to indicate the bit rate of the incoming data sequence to the ESG internal BER analyzer. When operating in packet generator mode, a payload data gate signal is also provided on the ESG event two port. This gate signal is used to recover continuous PN9 payload data from an incoming *Bluetooth* packet sequence for BER analysis. Refer to the Basic measurements section for a detailed example of how these signals are used to perform BER analysis.

### Clock/gate delay

When clock and gate signals generated by the ESG are used to perform BER analysis, it is important to realize that the test signal transmitted by the ESG experiences a propagation delay through the device under test. As a result, the demodulated loopback signal must be realigned in time with the clock and gate signals at the input of the BER analyzer, Figure 18. Delay control over the clock and gate signals is provided by the software to enable realignment with the test signal at the input of the BER analyzer.

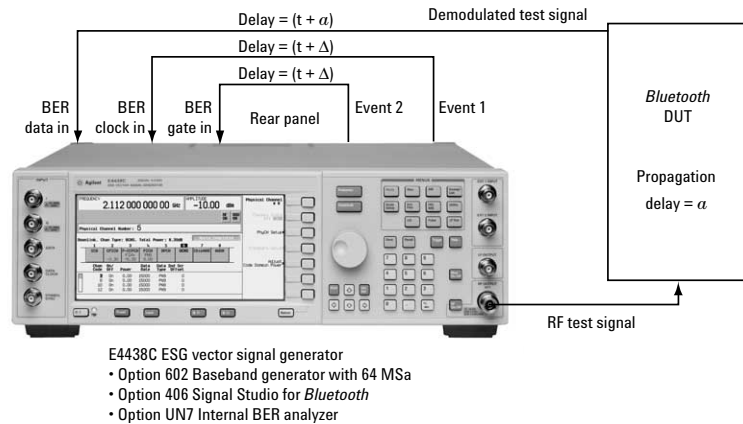

**Figure 18.** To perform BER analysis using this measurement setup, the clock/gate delay setting ( $\Delta$ ) must be equal to the propagation delay the test signal experiences through the *Bluetooth* device ( $\alpha$ ).

If the propagation delay characteristics for the device under test are known, enter the delay value in the clock/gate delay field during waveform configuration. The clock and gate signals associated with the waveform will be delayed by the indicated amount during waveform playback. The resolution of the clock/gate delay parameter is directly coupled to the oversampling ratio setting. It can be determined by dividing the symbol period (1  $\mu$ s) by the oversampling ratio. To increase the incremental delay resolution, increase the oversampling ratio of the configured waveform. When doing so, remember that increasing the oversampling ratio also increases the projected length of the waveform.



## Creating Signals

### Clock/gate delay calibration

If the delay parameter is unknown, leave the default value (0  $\mu$ s) in the clock/gate delay field and finish configuring the waveform. After the waveform has been calculated, the clock/gate delay calibration utility can be used to determine the delay characteristics of the device under test.

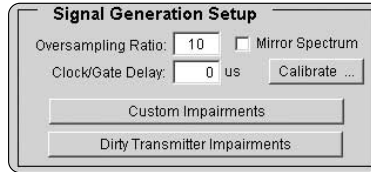

Figure 19. Signal Generation Setup menu.

After the waveform has been downloaded to the ESG, select the calibrate button in the Signal Generation Setup menu, Figure 19, to bring up the clock/gate delay calibration utility, Figure 20. Once configured, the calibration utility generates a plot of BER versus clock/gate delay. From the plot, the correct clock gate delay setting to realign the signals at the input of the BER analyzer can be determined.

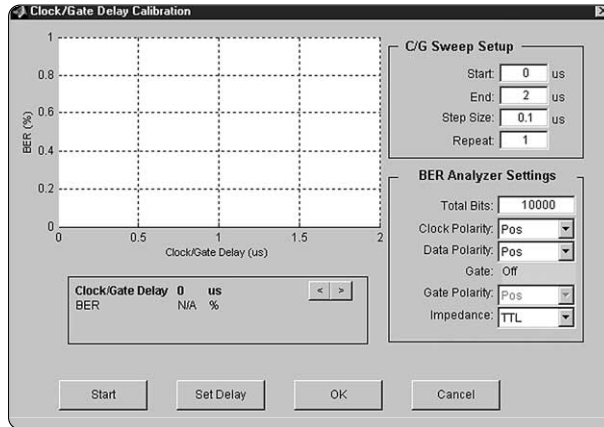

Figure 20. Clock/Gate Delay Calibration utility.

The Clock/Gate Sweep Setup menu is used to configure the calibration utility, Figure 21. Enter the Clock/Gate Delay range in the Start and End fields. Typical propagation delay through a *Bluetooth* device ranges from one to 10  $\mu$ s; however, depending on the test setup, longer delays are possible.

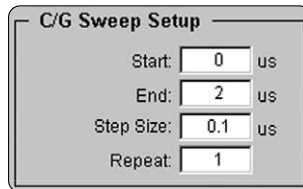
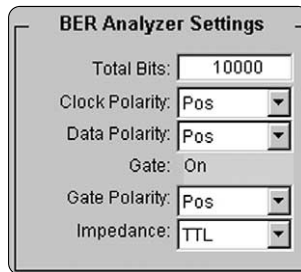

Figure 21. Clock/Gate Sweep Setup menu.

## Creating Signals

The incremental delay step at which BER tests are performed is set in the step size field. The resolution of this field is also directly coupled to the oversampling ratio setting as described previously. The Repeat field is used to set the number of BER test iterations for each clock/gate delay increment. When this field is set to two or greater, the BER results are plotted on the graph for each iteration of the measurement. By increasing the number of BER test repetitions, it can easily be determined if repeatable results are achievable.

The ESG internal BER analyzer settings required to perform the clock/gate delay calibration are also configured remotely using the Signal Studio software, Figure 22. The total number of data bits to be analyzed at each delay increment is set in the total bits field. The gate signal is automatically enabled in packet generator mode and disabled in data stream mode. The default polarity of the clock, data, and gate signals is set to positive. This is the correct setting for the basic measurement setup and should not be modified unless there is a need to do so in a particular application.



BER Analyzer Settings	
Total Bits:	10000
Clock Polarity:	Pos
Data Polarity:	Pos
Gate:	On
Gate Polarity:	Pos
Impedance:	TTL

Figure 22. ESG internal BER Analyzer setup menu.

Once configured, initiate the BER test sequence by pressing the **Start** button. A plot of BER vs. clock/gate delay will be incrementally filled in as each BER test in the sweep is completed. With no impairments added to the signal, a delay that results in 0 % BER should be achievable.

After the plot has been generated, a marker is automatically placed at the clock/gate delay setting with the minimum BER test results. The results section directly below the graph is updated to reflect the marker position. The arrow buttons can be used to incrementally move the marker to other points on the curve. The clock/gate delay setting and corresponding BER are continuously updated in the results section as the marker is moved across the graph. If the Repeat field is set to 2 or greater, the minimum, maximum, and average BER is provided in the results section for each clock/gate delay increment.

An example plot is provided in Figure 23. In this case, the repetitions field was set to three. The dots indicate the individual results for each clock/gate delay increment (note that some results overlap). The triangles are placed at the average BER for each clock/gate delay increment.

## Creating Signals

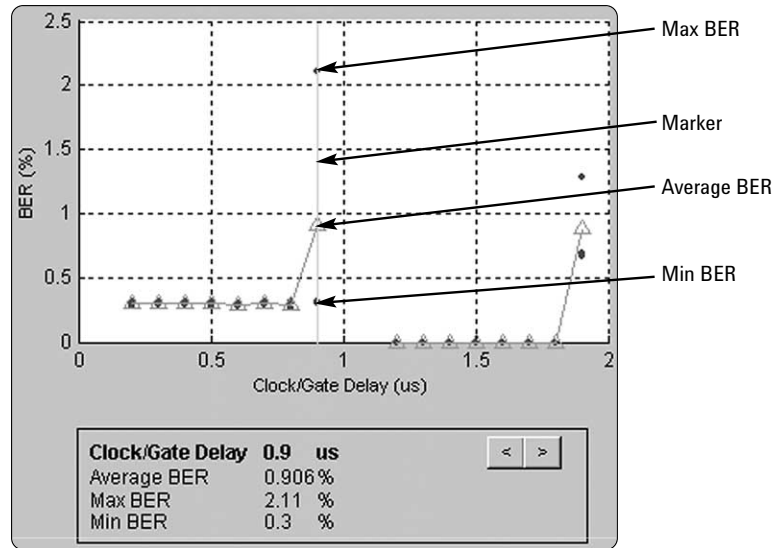

Figure 23. Plot of BER vs. Clock/Gate Delay with repetitions field set to three.

The statistics displayed in the box in figure 23 are the current marker value and not for the entire plot. All the repetitions are summed internally. The maximum, minimum, and average for each delay point are plotted on the graph.

When the **Set Delay** Button is selected, see figure 20, the delay setting of the current marker location is returned to the Clock/Gate Delay field in the Signal Generation Setup menu. As a result, it is important to remember to return the marker to the delay setting that yields the minimum BER test results prior to pressing the **Set Delay** button.

After pressing the **Set Delay** button, select the **OK** button to close the Clock/Gate Delay calibration utility and return to the main user interface. The BER calibration can be aborted at any time by pressing the **Cancel** button.

An example is provided in the Basic Measurements section of this document that details the measurement setup and procedure for performing Clock/Gate Delay calibration.

### Marker rotate SCPI command

To adjust the clock/gate signal delay, the Signal Studio software sends a marker rotate SCPI command to the ESG baseband generator. The marker rotate feature currently only exists in the Signal Studio for *Bluetooth* software. There is no equivalent soft key available in the ESG dual arb menu. The marker rotate SCPI command can also be used when setting up custom SCPI based test routines. The command and description are provided below for reference.

#### Marker rotate

`[[:SOURce]:RADio:ARB:MARKer:ROTate "filename", <rotate_count>.`

The marker rotate SCPI command shifts the I/Q waveform markers by the indicated number of samples in the rotate\_count field. The shift is based on the current position of the markers. The rotate\_count cannot exceed +/- (number of sample points - 1).

## Creating Signals

### Signal impairments

The Signal Studio software provides a straightforward graphical menu for adding impairments to the *Bluetooth* signal. Custom- and standards-based dirty transmitter impairments can be added to the *Bluetooth* signal. See Figure 24.

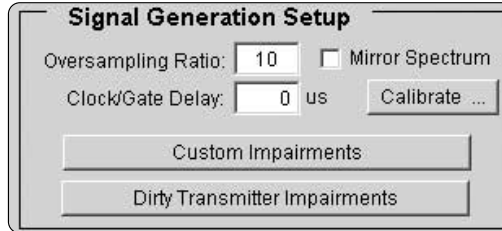

Figure 24. Add either custom- or standards-based dirty transmitter impairments.

In general, the impairments are derived from the frequency and modulation tolerances specified for *Bluetooth* transmitters. Adding these impairments enables the evaluation of receiver performance with signals realistically anticipated from *Bluetooth* transmitters. All impairments required by the *Bluetooth* RF Test Specification to perform single- and multi-slot sensitivity tests are provided in Signal Studio for *Bluetooth*.

The full complement of impairment conditions can be used for testing a given frequency, or a study can be done to determine the greatest contributors to error in symbol timing recovery. Many of the specified impairment conditions are not stressing enough to access the design limitations of the devices. These studies would allow the designer to optimize the receiver algorithms for symbol recovery, and extend the sensitivity levels achieved.

### Dirty transmitter impairments

Clicking the **Dirty Transmitter Impairments Setup** button in the Signal Generation Setup menu brings up the Dirty Transmitter Test configuration menu. See Figure 25. This menu is completely independent of the main Signal Studio for *Bluetooth* menu. The settings in the Dirty Transmitter Test configuration menu are not coupled with the main Signal Studio for *Bluetooth* menu, and vice versa. While the Dirty Transmitter Test configuration menu is active, settings in the main Signal Studio for *Bluetooth* menu are disabled and cannot be modified until the Dirty Transmitter Test menu is closed.

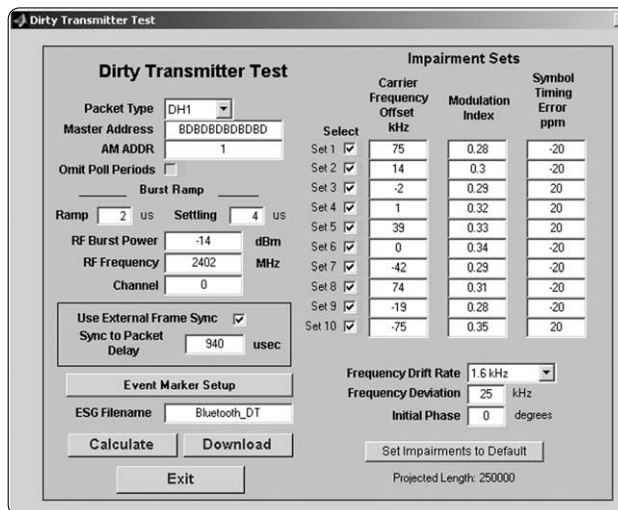

Figure 25. Dirty Transmitter Test menu

## Creating Signals

The *Bluetooth* dirty transmitter test signal is used to verify the demodulation capabilities of the receiver. The ESG and Signal Studio for *Bluetooth* software's dirty transmitter test capability provides a versatile solution for receiver development and *Bluetooth* module verification. The ESG provides unrivaled impairment flexibility for receiver development.

### Impairment Sets

The Special Interest Group (SIG) has defined a set of 10 signal impairments as a suite of tests called "*Bluetooth* Dirty Transmitter" tests. The default Impairment Sets, see Figure 26, is the prescribed suite that is specified in the *Bluetooth* SIG's RF Tests for Single and Multi-slot Sensitivity, RCV/CA/01/C and RCV/CA/02/C (see Table 1, Section 1.1 of the specification).

Select	Carrier Frequency Offset kHz	Modulation Index	Symbol Timing Error ppm
Set 1 <input checked="" type="checkbox"/>	75	0.28	-20
Set 2 <input checked="" type="checkbox"/>	14	0.3	-20
Set 3 <input checked="" type="checkbox"/>	-2	0.29	20
Set 4 <input checked="" type="checkbox"/>	1	0.32	20
Set 5 <input checked="" type="checkbox"/>	39	0.33	20
Set 6 <input checked="" type="checkbox"/>	0	0.34	-20
Set 7 <input checked="" type="checkbox"/>	-42	0.29	-20
Set 8 <input checked="" type="checkbox"/>	74	0.31	-20
Set 9 <input checked="" type="checkbox"/>	-19	0.28	-20
Set 10 <input checked="" type="checkbox"/>	-75	0.35	20

Frequency Drift Rate: 1.6 kHz  
Frequency Deviation: 25 kHz  
Initial Phase: 0 degrees

Set Impairments to Default

Projected Length: 250000

Figure 26. Impairment sets

You can select each impairment set individually, and all parameters in the different fields can be modified. In addition, any number of impairment sets may be selected. For example, if only one is selected, a waveform with the selected impairment set will be repeatedly transmitted. Otherwise, after the required 20 ms, each of the following selected impairment sets will be transmitted.

### Carrier frequency offset

This impairment adds a static error to the transmission frequency. It is used to simulate a *Bluetooth* device transmitting at a frequency slightly offset from the specified carrier.

### Modulation index

The modulation index is the ratio of peak-to-peak frequency deviation to the bit rate. Modifying this parameter impairs the peak-to-peak frequency deviation only.

## Creating Signals

### Symbol timing error

This impairment varies the symbol rate of the *Bluetooth* signal. Adding this impairment adjusts the standard one Msymbol/second rate by the set amount.

### Carrier frequency drift

This impairment adds a dynamic error to the transmission frequency. It is used to simulate a *Bluetooth* device's carrier frequency varying during the transmission of a packet. The frequency drift impairment repeats at the beginning of each timeslot, and occurs across a period of time equal to the duration of the packet. Figure 27 illustrates the carrier frequency drift impairment for a single-slot packet. This concept can be extended to multi-slot packets as well. The maximum frequency drift deviation is user defined.

### Sinusoidal drift

The carrier frequency drifts above and below its designated center carrier frequency in a sinusoidal fashion. The sinusoidal drift rate is defined in the Rate pull-down menu.

- Single slot packet, drift rate = 1.6 kHz
- Three slot packet, drift rate = 500 Hz
- Five slot packet, drift rate = 300 Hz

The sinusoidal drift is automatically set according to the packet type chosen.

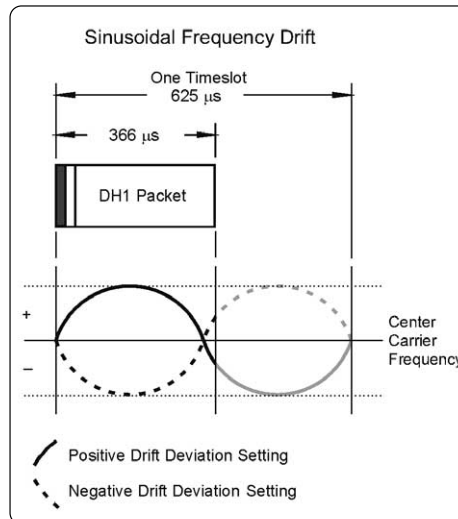

Figure 27. Sinusoidal carrier frequency drift impairment

The drift is over the duration of the packet and returns to the start value after each packet.

### Frequency deviation

Since packets are slightly shorter than the number of timeslots they occupy, they are not fully impaired by the second half of the drift cycle. Therefore, it is recommended you test separate positive and negative drift impairment cases by changing the drift deviation setting (for example, 25 kHz and -25 kHz).

### Initial phase

The initial phase of the sinusoidal frequency deviation can be adjusted by setting this field.

### Set impairments to default

Sets all dirty transmitter impairments to the values specified by the *Bluetooth* test specification.

## Creating Signals

### Packet types

The three different packet types that can be chosen for the dirty transmitter test are DH1, DH3, and DH5. The payload for all packet types is a PN9 data sequence. The PN9 data sequence is truncated after the maximum amount of PN9 data has been placed in the packet. Since this is truncated data, these packets cannot be used with the ESG's option UN7 BER analyzer, which requires a continuous PN sequence. The payload length of each packet type is as follows:

- DH1=27 bytes
- DH3=183 bytes
- DH5=339 bytes

Each impairment set consists of two to four packets. The sequence bit in the header field is toggled for the second and fourth packet to indicate to the *Bluetooth* device that the incoming packet is not a re-transmitted packet.

### Poll period

In *Bluetooth* systems, master and slave devices exchange information by alternating packet transmission in TDD mode. The poll period is used to simulate the time period when the other *Bluetooth* device would be transmitting its packets. The omit poll period section allows for verification setups where the *Bluetooth* TDD mode can be ignored; instead the ESG will create *Bluetooth* packets for every time slot. This selection will be beneficial when comparing results against normal TDD mode to determine the effects of LO switching, or for comparing other state machine transitions. In characterizing receiver performance, or for high-speed verifications, we recommended you omit the poll period.

Figure 28 shows the timing diagram for each of the three packet types. The poll period is 625 microseconds long, and data is not transmitted during this period. The poll period is transmitted before each packet type, unless omit period is enabled. The amount of poll period(s) for each packet type is as follows:

- DH1=1 poll period
- DH3=3 poll periods
- DH5=5 poll periods

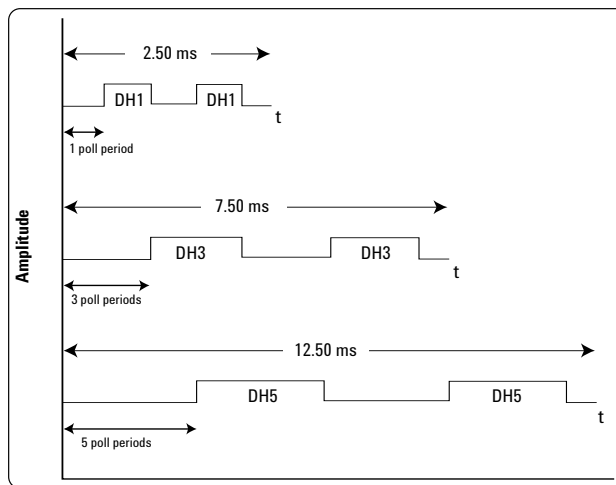

Figure 28. Timing diagram for test set for each packet type. ~~Use with External Frame Sync~~ not selected. ~~Use with External Frame Sync~~ is selected, the DH1 impairment set consists of four packets.

## Creating Signals

### Use with an external frame sync

Selecting the Use External Frame Sync field, see Figure 29, sets up the waveform to trigger from an externally-supplied signal that is applied to the pattern trigger In connector on the ESG's rear panel. The waveform sequence will trigger after it detects a change in TTL state from low to high at the **Pattern Trigger In** connector. The trigger signal can come from a function generator, or any other source that can produce a repetitive TTL signal at the *Bluetooth* frame rate. The frame rate varies according to the packet type selected.

A delay time may be entered in the Sync to Packet Delay field, which is the time from an external frame trigger signal to the first symbol,  $p_0$ , of the *Bluetooth* packet. The valid range of values that may be entered for the Sync to Packet Delay is as follows:

- DH1 packets:  $\pm 1754$  ms
- DH3 packets:  $\pm 5504$  ms
- DH5 packets:  $\pm 9254$  ms

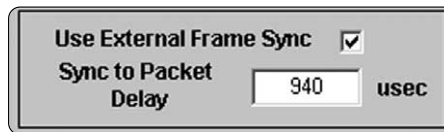

Figure 29: Trigger the waveform from an external frame trigger signal and enter delay amount.

Figure 30 shows the timing relationship of a DH1 packet sequence relative to an external frame clock signal.

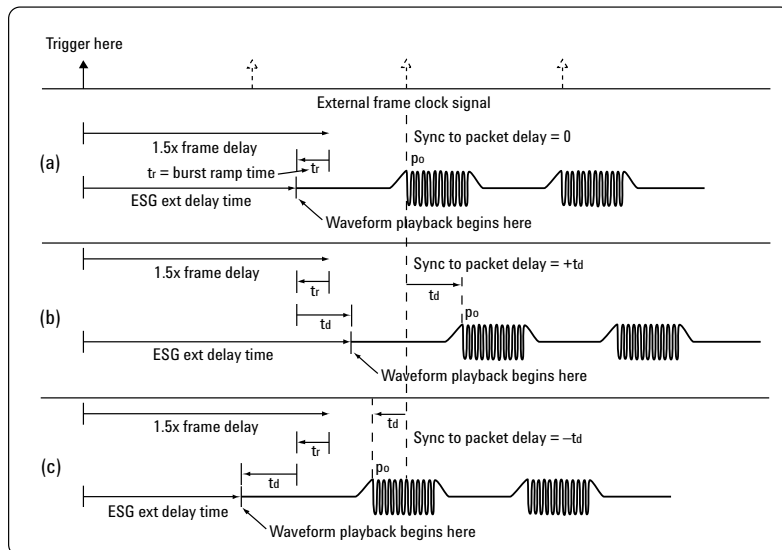

Figure 30: DH1 waveforms triggered from an external frame clock signal timing diagram.  
**NOTE:** The additional signals, illustrated with dotted arrows, the ESG receives during the playback of the dirty transmitter test sequence is ignored. When the playback of the sequence is completed, then the next trigger signal will start the playback of the next sequence.



## ***Creating Signals***

Three different waveforms are shown in Figure 30, and each waveform has the same value for the burst ramp. The burst ramp,  $t_r$ , includes the power ramp and power settling times. The sync to packet delay,  $t_d$ , is different for each of the waveforms:

- Figure 30 (a)  $t_d = 0$
- Figure 30 (b)  $t_d = + \text{value}$
- Figure 30 (c)  $t_d = - \text{value}$

The external frame clock repeats every 1250 ms. Any additional triggers that are received during the waveform playback time are ignored by the ESG until after the waveform has played back completely.

When each waveform is initially triggered from an external source, there is a 1.5 frame delay. The ESG ext delay time is the amount of delay time, after the ESG receives the trigger signal, before the waveform begins playing back. This delay time is computed as follows:

Ext Delay Time =  $1.5 * \text{Frame Length} + \text{Sync to Packet Delay} - \text{Burst Ramp}$ .

The frame lengths are as follows:

- DH1 = 1250 ms
- DH3 = 3750 ms
- DH5 = 6250 ms

**Note:** Selecting the External Frame Sync will disable Omit Poll Period, if Omit Poll Period is enabled. Once the External Frame Sync is de-selected, the Omit Poll Period will become re-enabled.

## Creating Signals

### Trigger setup for the ESG

The ESG includes several different triggering types and sources.

For more details on the different trigger types and sources available, and how to set up, please refer to the E4438C ESG Vector Signal Generator User's Guide.

### Event marker setup

The Signal Studio software makes use of the ESG markers to generate various signals out the Event 1 and 2 ports on the back of the rear panel of the ESG. See Figure 31. Markers provide timing signals that are synchronized with a waveform segment.



Figure 31. Dirty Transmitter Event Markers menu

## Creating Signals

### Event 1 Marker

Two different marker options are available for the signal out the Event 1 port located on the rear panel of the ESG.

#### 1 microsecond pulse

When you select this choice as a marker, a single 1  $\mu$ s pulse is transmitted at the first symbol of the packet. The user has the option to set the position of marker 1 relative to the start of the packet preamble,  $p_0$ . The offset can be negative unless you select **Omit Poll Period**.

#### Symbol clock

When you select this choice as the marker, the symbol clock is transmitted. This is a repeating 1  $\mu$ s pulse, which is transmitted during the packet period. It does not include the ramping portion of the burst.

### Event 2 Marker

Four different marker options are available for the signal out the Event 2 port located on the rear panel of the ESG.

#### Burst

When you select this choice as the marker, a marker is set high at the beginning of the burst ramp and remains high through burst ramp down. The ALC is enabled only for the RF burst duration, and disabled otherwise. During the off portion of the RF burst, the RF carrier is blanked. RF blanking improves the signal quality by increasing the on/off ratio of the RF bursts. If the burst marker is not used, and the ALC is on, the *Bluetooth* packets may experience slight amplitude variation during the packet transmission. This is due to the ALC trying to correct for the bursted transmission.

If you are not using the burst marker for Event 2, it is suggested to turn the ALC off and use the ESG power search feature to achieve better power level accuracy. Power search mode executes a power search routine that temporarily activates the ALC, calibrates the power of the current RF output, and then disconnects the ALC circuitry.

When using the power search mode, it is suggested to perform the power search on a non-bursted *Bluetooth* signal. A non-bursted *Bluetooth* signal cannot be chosen from the Dirty Transmitter menu. From the main *Bluetooth* menu, generate a framed signal with the desired packet type, and disable the Bursting Active field. Once the power search is performed on this non-bursted signal, return to the Dirty Transmitter menu and continue signal setup. Make sure the power settings are the same for both the main *Bluetooth* menu and the Dirty Transmitter menu.

For more details about the power search feature, please refer to the *E4438C ESG Vector Signal Generator's User's Guide*.

#### Packet

When you select this choice as the marker, a marker is set high with the first symbol in the packet and remains high until the last symbol in the packet.

#### Payload

When you select this choice as the marker, a marker is set high beginning with the first symbol of the payload data and remains high until the last symbol of the payload data.

#### Payload + CRC

When you select this choice as the marker, a marker is set high beginning with the first symbol of the payload data and remains high until the last symbol of the 16-bit CRC that is appended to the end of the payload data.

## Creating Signals

### Other features

The features that are not explained in the impairments section are explained elsewhere in the other sections of this product note. Please refer to the following sections for details regarding the following features:

#### Configure the *Bluetooth* signal section

- Master (BD ADDR)
- AM ADDR
- Burst Ramp

#### Configure the *ESG* section

- RF Burst Power
- RF Frequency
- Channel
- ESG Filename

#### Configure the *ESG* section

- Calculate
- Download

### Custom impairments

Selecting the **Custom Impairments** button, located in the Signal Generation Setup section, shows the following menu, see Figure 32. Each impairment can be enabled or disabled using the box to the left of the desired impairment. Many of the impairments in this menu are the same as described for the Dirty Transmitter Test impairments. However, there are some additional impairments that are offered in this menu.

Note: A dirty transmitter test sequence cannot be created from the Custom Impairments menu. The symbol timing error is implemented differently in the Custom Impairments menu than in the Dirty Transmitter impairments menu.

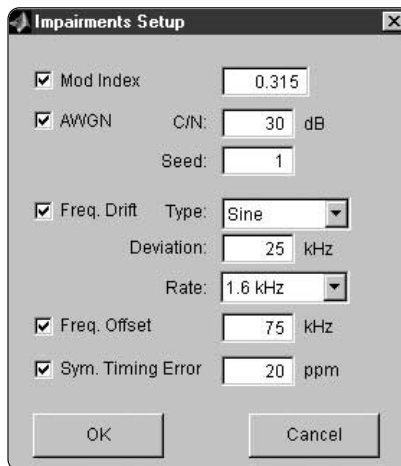

Figure 32. Custom Impairments Setup menu

## Creating Signals

### Linear drift

The two different carrier frequency drift types that are available in the menu are sine and linear. When linear drift is selected, the carrier frequency deviates from the center carrier frequency in a positive or negative linear direction, depending on the drift deviation setting. For example, a drift deviation setting of  $-15$  kHz would cause the carrier frequency to drift in a linear fashion from 0 to 15 kHz below the intended carrier frequency.

The drift is over the duration of the packet and returns to the start value after each packet.

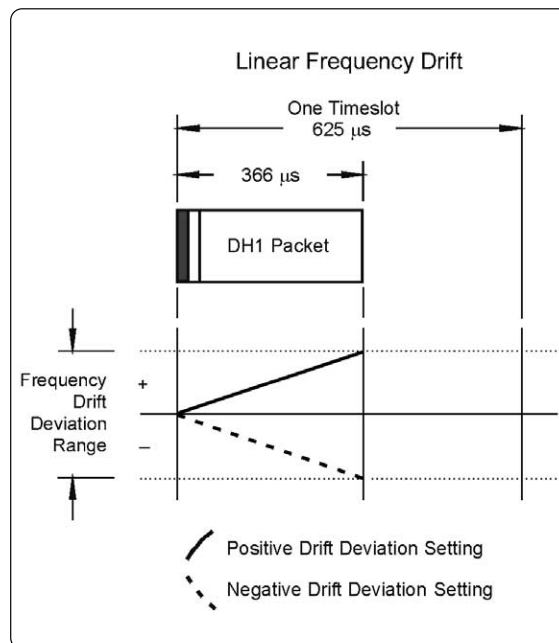

Figure 33. Linear frequency drift impairment

### Additive white Gaussian noise (AWGN)

This impairment adds noise to the *Bluetooth* signal. Although not required by the *Bluetooth* RF test specification, this impairment enables the simulation of non-ideal environments for receiver performance evaluation. The carrier-to-noise ratio and the noise seed are user defined. The noise seed initializes the 16-bit shift register used for noise generation. When repeating measurements, using the same noise seed for each measurement iteration increases the probability of replicating test results.

### Step 3 Configure the ESG

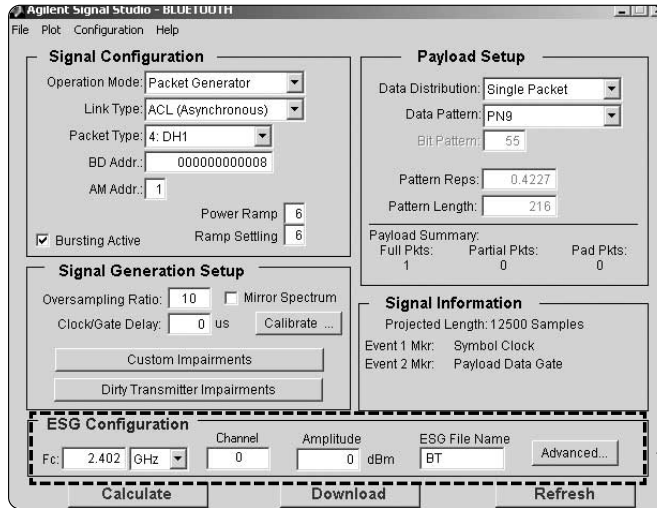

Figure 34. ESG Configuration menu.

In addition to the configured *Bluetooth* waveform, the Signal Studio software passes instrument settings to the ESG. These are defined in the ESG Configuration menu, boxed in Figure 34.

#### Basic settings

There are three fundamental ESG settings that must be defined prior to downloading the waveform to the instrument.

##### Frequency

This field is used to set the frequency at which the ESG will generate the signal.

##### Amplitude

This field is used to set the power at which the ESG will generate the signal.

##### Channel

Selects RF carrier frequency from the channel number.

##### Waveform name

The alphanumeric text entered in the name field will appear in the ESG user interface after the waveform file is downloaded to the instrument. The ESG only recognizes waveforms that are named using the following alphanumeric characters:

- A thru Z
- 0 thru 9
- \$ & \_ # + - [ ]

If un-supported alphanumeric characters are used to name the waveform, the ESG will generate a file name not found error (Error: -256) when the waveform is downloaded to the instrument. There is a 20-character maximum name length for waveform files.

## Creating Signals

### Advanced settings

Additional ESG parameters can be accessed by selecting the advanced button in Figure 35. Typically, these parameters should not be modified unless there is a specific reason to do so. A brief description is provided below and additional information on these parameters can be found in the *E4438C ESG Vector Signal Generator User's Guide*.

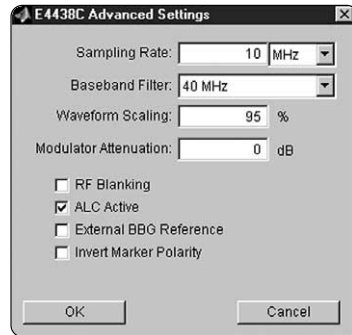

Figure 35. E4438C Advanced Settings menu.

#### Sampling rate

This parameter is automatically set when the oversampling ratio is defined in the Signal Generation Setup menu. It is the rate at which the waveform I/Q samples are read from the baseband generator memory during playback.

#### Baseband filter

The ESG provides three baseband filters [2.1 MHz, 40 MHz, and 50 MHz (through)]. The bandwidth of the baseband signal (1/2 the RF bandwidth) dictates the minimum reconstruction filter bandwidth to be used. Depending on the oversampling ratio and where the image frequencies appear, a wider bandwidth reconstruction filter may be selected.

#### Waveform scaling

The waveform scaling parameter is used to reduce the overshoot associated with the DAC interpolation filter. At 100 percent, some overshoot may occur; therefore the default setting is 95 percent. Further scaling may help to decrease DAC over-range occurrences.

#### Modulator attenuation

The modulator attenuation parameter is used to reduce the signal level driving the I/Q modulation block. Adjusting the attenuation may reduce signal distortion and improve the overall dynamic range.

#### RF blanking

When enabled, RF blanking improves the signal quality by increasing the on/off ratio of the RF bursts. The ESG event 2 marker is internally routed to provide the RF blanking signal. When RF blanking is active, the ALC is enabled only for the RF burst duration and disabled otherwise.

Note: Marker 2 is set up as a gate signal on the Signal Studio-Bluetooth main menu. The gate is placed over the payload portion of the packet. If RF Blanking is selected, then only the payload portion of the packet will be transmitted, and the other parts of the packet will be RF Blanked. For details on how to set markers, refer to the *E4438C ESG Vector Signal Generator User's Guide*.

#### ALC active

When enabled, the automatic level control (ALC) constantly monitors and controls the RF output power of the ESG. There are some modulation conditions which the ALC circuit cannot handle properly. For example, when RF blanking is disabled, DH3 and DH5 packets experience slight amplitude variation during the packet transmission. This is due to the ALC trying to correct for the burst transmission. In these conditions, turning the ALC off and using the ESG power search feature can achieve better power level accuracy.

## Creating Signals

### External BBG reference

The ESG baseband generator uses an internal reference clock as its time base. Alternatively, an external reference clock can be used as the time base by selecting External BBG reference. If an external reference is used, it should be connected to the ESG prior to downloading waveform and instrument settings.

### Invert marker polarity

Selecting invert marker polarity changes the polarity of the ESG event 1 and event 2 markers from positive to negative. The event 1 marker is used to generate the symbol clock and the event 2 marker is used to generate the payload data gate. Both signals are TTL level. Access to these signals is provided on the rear panel of the ESG. The default setting, positive, is correct if the marker signals are directly routed to the ESG internal BER analyzer clock and gate in ports.

## Step 4 Calculate and download

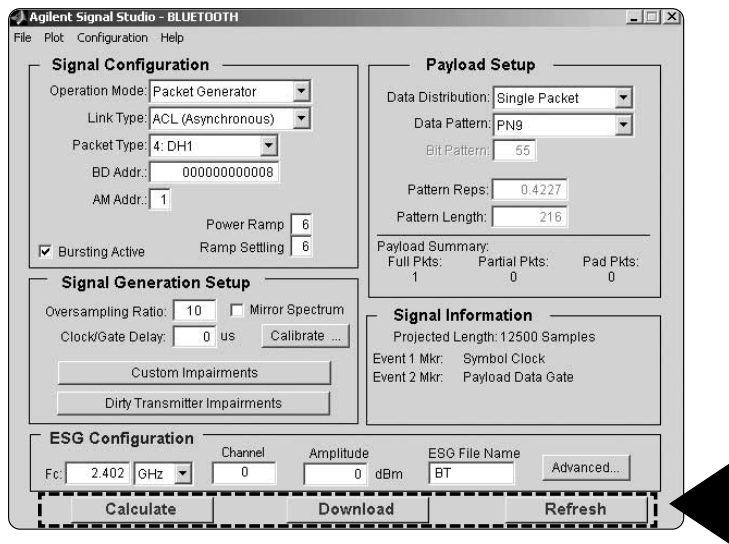

Figure 36. Calculate, download, and refresh functions.

Once the waveform and ESG settings have been configured, the final step is to calculate the waveform and download it to the instrument, Figure 36.

### Calculating waveforms

To initiate waveform calculation, select the **Calculate** button. The software will generate an I/Q waveform file in accordance with the current signal configuration. Waveform calculation typically takes only a few seconds.

### Plotting waveforms

After the I/Q waveform has been calculated, the Signal Studio software can generate a plot of the baseband spectrum, I/Q waveforms, and CCDF curve. To plot the spectrum, choose **Plot > Spectrum** from the menu keys at the top of the main user interface window, Figure 36. The plot can be magnified using the zoom feature in the Tools pull-down menu at the top of the plot, Figure 37. Simply select the zoom feature and use the mouse pointer to select the section of the plot to be affected. Plots of the I/Q waveforms and CCDF curve can be generated in a similar manner.





## Creating Signals

### *Saving the Signal Studio setup*

The Signal Studio software configuration can be saved to the host computer's local hard drive. The configuration can then be recalled at any time to re-calculate and download the waveform to the signal generator. This is especially useful when complex packet configurations have been created in the software. From the menu keys at the top of the window in Figure 36, choose **File>Save As**, and then name the file and save it in the Agilent\Signal Studio\E4438C\Bt directory. The software configuration can be recalled anytime by choosing the following menu options: **File>Open**, then the file name.

### *Saving waveforms*

After the calculated I/Q waveform has been downloaded to the signal generator for playback, it can be saved in the ESG non-volatile memory for storage and recalled at anytime for playback. Note that the instrument states are not stored in non-volatile memory along with the waveform. As a result, the ESG settings like frequency, amplitude, filter setting, ALC setting and sample rate will need to be reconfigured from the instrument's front panel when recalling waveforms from non-volatile memory for playback. Alternatively, when the waveform is initially downloaded to the instrument, the ESG instrument states can be saved using the SAVE hard key on the ESG front panel. The instrument state can then be recalled prior to selecting the desired waveform from non-volatile memory for playback. For more information on saving waveforms to the instrument, refer to the *E4438C ESG Vector Signal Generator Users Guide*.

### *Sequencing waveforms*

The ESG baseband generator is capable of sequencing several waveform segments. If multiple *Bluetooth* waveform files are configured and downloaded to the instrument, custom packet sequences can be created. From the Dirty Transmitter Test menu, the ESG automatically sets up the required waveform sequence required for dirty transmitter tests. Waveform sequences cannot be set up from the main Agilent Signal Studio for *Bluetooth* menu. General waveform sequence setup is accomplished through the ESG dual ARB user interface. For more information on setting up waveform sequencing, refer to the *E4438C ESG Vector Signal Generator User's Guide*.

### *Refresh*

The refresh function is used to update ESG configuration parameters, like frequency and amplitude, without recalculating the waveform. For example, after the waveform has been downloaded to the instrument, the Frequency field can then be modified. To initiate the change, select the **Refresh** button, and a SCPI command is sent to the ESG to modify the frequency setting.

---

## Basic Measurements

### Receiver measurements

---

The *Bluetooth* RF test specification outlines several test scenarios under which receiver performance must be verified. These tests are intended to ensure that receivers in all *Bluetooth* devices meet a minimum performance criterion. A general overview of the *Bluetooth* receiver test cases can be found in Application Note 1333-1: *Bluetooth RF Measurement Fundamentals*.

---

### ESG BER analysis capability

---

When performing *Bluetooth* receiver measurements, bit-error-rate (BER) is used as a gauge to verify compliant operation. This section describes the ESG vector signal generator's BER analysis capabilities.

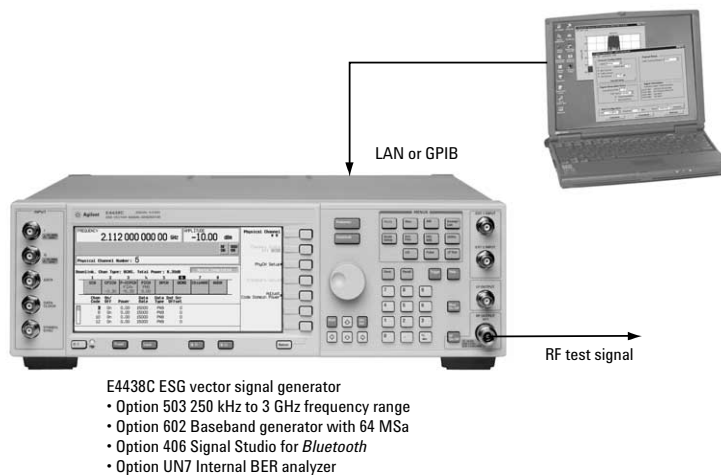

**Figure 39. ESG configuration required to perform *Bluetooth* BER analysis.**

The ESG internal BER analyzer is capable of analyzing framed and unframed continuous PN9, PN11, PN15, PN20, and PN23 baseband data sequences only. Performing BER analysis on unframed data requires two signals (data and clock) while framed data requires three signals (data, clock, and gate). The clock signal is used to indicate the bit rate of the incoming data sequence to the BER analyzer. The gate signal is used to enable the BER analyzer only when the continuous PN9 or PN15 baseband data portion of a frame is present for analysis. When performing *Bluetooth* BER measurements, the gate signal is used to recover the continuous PN9 payload data portion of a *Bluetooth* packet sequence. Figure 39 indicates the required ESG configuration to perform BER analysis on *Bluetooth* signals generated by Signal Studio.

---

## Basic Measurements

### BER measurement setup

The ESG does not establish a link with a *Bluetooth* device; however, different BER measurement setups can still be achieved on *Bluetooth* devices that internally implement various test modes. These test modes do not require a link to be established. The most common are the “continuous receive” test modes and a “loopback” test modes. Measurement setups for both are discussed below.

#### “Continuous receive” operating mode

A *Bluetooth* device in “continuous receive” operating mode must provide access to the demodulated *Bluetooth* signal in order to perform BER measurements. Access is typically provided at the FM demodulator or baseband processor output. The ESG BER analyzer data input impedance is TTL and CMOS compatible. The input thresholds to option UN7 are adjustable. The acceptable Hi/Lo thresholds are as follows:

- 0.7 V [TTL]
- 1.4 V [TTL]
- 1.65 V [CMOS 3.3]
- 2.5 V [CMOS 5.0]

An example BER measurement setup is illustrated in Figure 40. In this setup, the ESG is configured to provide a *Bluetooth* modulated RF signal using Signal Studio. The RF test signal consists of a sequence of *Bluetooth* modulated DH1 packets with continuous PN9 payload data.

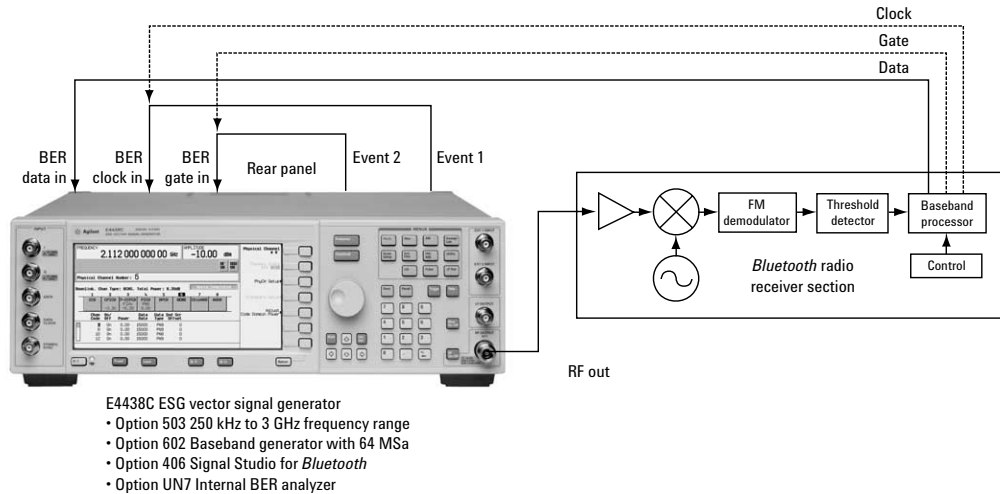

**Figure 40. BER test setup for a *Bluetooth* device in “continuous receive” operating mode.**  
Note: Dashed lines indicate alternate configurations.

## Basic Measurements

The *Bluetooth* receiver demodulates the signal transmitted by the ESG and provides access to the *Bluetooth* baseband signal (packets or continuous data stream) at the baseband processor output. This signal is routed to the ESG internal BER analyzer data input.

If recovered clock and gate signals are also available from the *Bluetooth* device's baseband processor, these signals should be used to perform the BER analysis. Using these signals provides a more functional test of receiver clock recovery capability. Furthermore, these signals have experienced the same propagation delay as the demodulated *Bluetooth* signal. Hence, they do not need to be realigned at the input of the BER analyzer.

If the *Bluetooth* device does not provide the clock or gate signal, the clock and gate signals generated by the ESG can be used to perform the BER analysis. The delay setting found using the Signal Studio clock/gate delay calibration feature should be used to realign the clock/gate signals generated by the ESG with the demodulated *Bluetooth* signal at the input of the BER analyzer.

### "Loopback" operating mode

The ESG is not capable of demodulating a *Bluetooth* RF signal. Therefore, to perform BER analysis on a *Bluetooth* device operating in a "loopback" test mode, additional equipment is required to demodulate the *Bluetooth* RF loopback signal. In the test setup shown in Figure 41, the ESG vector signal generator and ESA-E Series spectrum analyzer combine to provide a powerful BER test solution for *Bluetooth* devices operating in "loopback" mode.

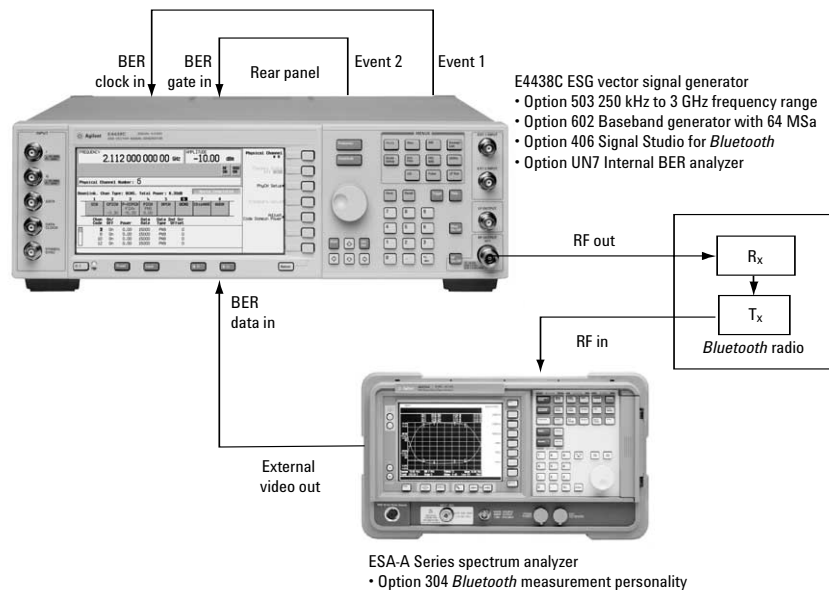

Figure 41. BER test setup for a *Bluetooth* device operating in "loopback" mode.

## Basic Measurements

In this example, the ESG is configured to provide a *Bluetooth* modulated RF signal using the Signal Studio software. The RF test signal consists of a sequence of *Bluetooth* modulated DH1 packets with continuous PN9 payload data.

In “loopback” mode, the *Bluetooth* device receives, demodulates, and decodes the RF signal transmitted by the ESG. The device then re-transmits the recovered continuous PN9 payload data in the same packet type that it received from the ESG. The *Bluetooth* device’s internal test mode must be capable of this operation to perform BER analysis in this configuration.

The ESA-E series spectrum analyzer with the *Bluetooth* measurement personality is used to receive and demodulate the RF loopback signal from the *Bluetooth* device. Access to the demodulated signal is provided on the external video out port of the ESA-E.

The clock and gate signals generated by the ESG are used to recover the continuous PN9 payload data portion of the *Bluetooth* packet for BER analysis. The delay setting found using the Signal Studio clock/gate delay calibration feature should be used to realign the clock/gate signals with the demodulated *Bluetooth* signal at the input of the BER analyzer.

### BER measurement example – Clock/gate delay calibration

This example illustrates the procedure for performing clock/gate delay calibration using Signal Studio. In this example, the measurement setup illustrated in Figure 42 is used. This is very similar to the test setup illustrated in Figure 40; however, for demonstration purposes, the Agilent ESA series spectrum analyzer (with the *Bluetooth* measurement personality) is used to demodulate the *Bluetooth* signal generated by the ESG instead of an actual *Bluetooth* receiver.

Note: The ESA does not decode the *Bluetooth* signal. Therefore, packets that implement FEC on the payload data portion of the packet should not be used in this test setup.

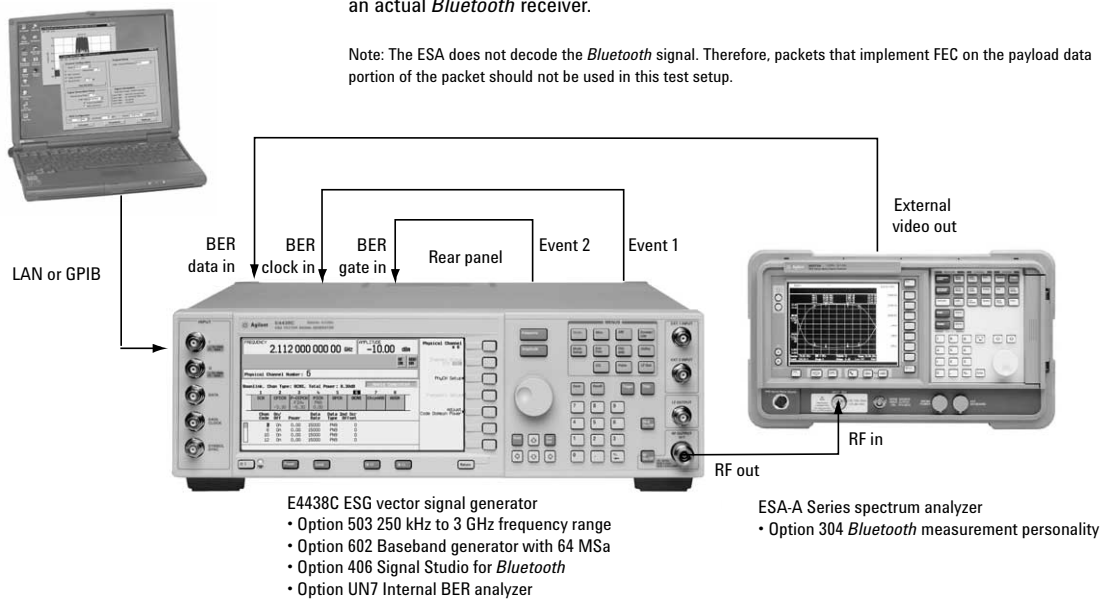

Figure 42. Example BER measurement set up using the ESA to demodulate the *Bluetooth* signal generated by the ESG.

## Basic Measurements

### Instrument instructions for performing measurements:

Keystrokes surrounded by [ ] indicate hard keys located on the instrument front panel.  
Keystrokes surrounded by { } indicate soft keys located on the right side of the display.

### Procedure

1. Connect the test setup as shown in Figure 42 and preset the ESG.

Instructions: E4438C ESG vector signal generator	Keystrokes: E4438C ESG vector signal generator
Preset the instrument	[Preset]
Set the threshold level	[Aux Fctn] {BERT} {I/Q Setup} {Threshold} {0.7V}

2. Configure the ESA to demodulate the *Bluetooth* signal generated by the ESG.

Instructions: E4402B ESA	Keystrokes: E4402B ESA
Preset the instrument	[Preset]
Set the frequency to <i>Bluetooth</i> channel #1 (2.402 GHz)	[Frequency] [2.402] {GHz}
Set the span to 0 Hz	[Span] {Zero Span}
Set the resolution bandwidth to 5 MHz	[BW/Avg] {Resolution BW} [5] {MHz}
Set the video bandwidth to 3 MHz	{Video BW} [3] {MHz}
Set the sweep time to 40 us	[Sweep] {Sweep Time} [40] {us}
Set the trigger to continuous	[Trig] {Free Run}
Turn auto alignments off	[System] {Alignments} {Auto Align} {Off}
Note: If Auto-Alignments is not turned off, additional bit errors will occur when the ESA-E re-calibrates the IF, because the Ext. video out signal is temporarily interrupted.	
Turn FM demodulation on	[Det/Demod] {Demod} {FM}

## Basic Measurements

3. Use Signal Studio to configure a DH1 multi packet sequence that contains continuous PN9 data distributed over the user payload portion of the packet sequence, Figure 43. Do not add impairments to the signal when performing the initial calibration. Once configured, select the **Calculate** button.

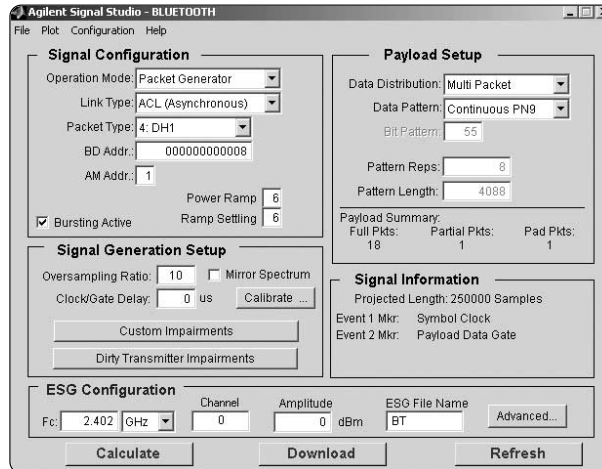

Figure 43. Signal Studio Configured to create a DH1 multi packet sequence with continuous PN9 data spread over the user payload portion of the sequence.

4. Use the calibrate utility to determine the signal propagation delay through the ESA. Select the **Calibrate** button in Figure 44. The calculated waveform is automatically downloaded to the ESG and the calibration utility is initiated.

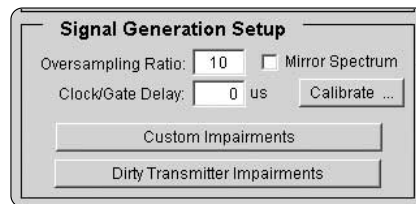

Figure 44. Signal Generation Setup menu.



## Basic Measurements

5. Configure the automated clock/gate delay calibration utility, Figure 45. In this example, the clock/gate sweep end field is set to 10 us. Default values are used for the remaining configuration fields.

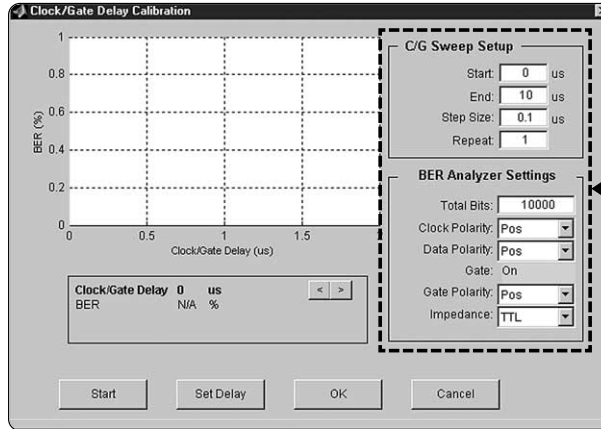

Figure 45. Clock/Gate Delay calibration utility setup.

6. Once configured, select the **Start** button to generate the plot of BER vs. clock/gate delay. The plot points are incrementally filled in as each test iteration is completed.

7. After the plot has been generated, a marker is automatically placed at the clock/gate delay setting that yields the minimum BER, Figure 46. Notice that the plot looks similar to a step function. With no impairments added to the signal, there is a range of approximately 1/2 a symbol period that yields the same BER results. In this case, the marker is placed at the first BER minimum. When impairments are added to the signal, the plot no longer looks like a step function. Instead, it looks like a series of parabolas, from which a true minimum can be found. By initially performing the calibration without impairments added to the signal, the clock/gate delay range for optimum BER can easily be determined. As a result, when later performing clock/gate delay calibration on an impaired signal, the sweep range can be adjusted accordingly.

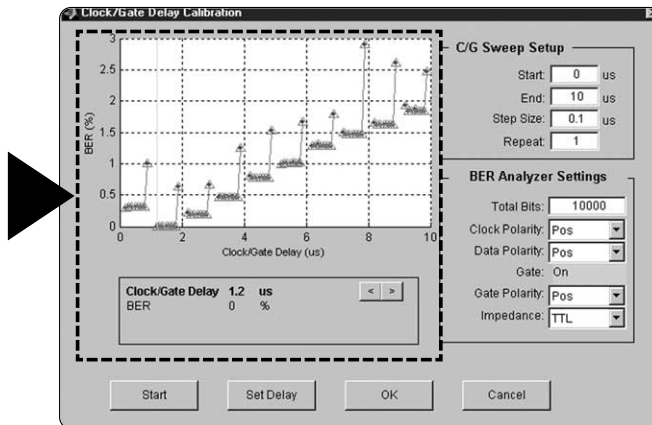
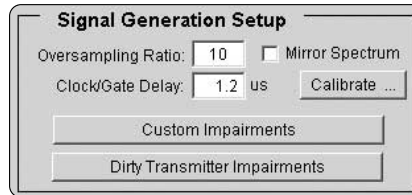

Figure 46. BER vs. Clock/Gate Delay calibration results.

## Basic Measurements

8. Place the marker at the desired clock/gate delay setting using the arrow buttons and select the set **Delay** button. Then select the **OK** button. The clock/gate delay setting associated with the current marker location is returned to the clock/gate delay field, Figure 47, in the Signal Generation Setup menu and the calibration utility is closed.



**Figure 47. Signal Generation Setup menu with clock/gate delay setting returned from the calibration utility.**

9. To apply the optimum clock/gate delay setting returned from the calibration utility to the configured waveform, re-calculate and download the waveform to the ESG.

As demonstrated, the calibration utility removes the trial and error uncertainty when determining the optimum clock/gate delay setting for performing BER test on *Bluetooth* devices.

---

## Signal Studio for Bluetooth features<sup>1</sup>

<b>Data streams</b>	0s, 1s, 01s, 10s, 8-bit pattern, PN9, PN15
<b>Packet types</b>	
<b>ACL</b>	DH1, DH3, DH5, DM1, DM3, DM5, AUX1
<b>SCO</b>	HV1, HV2, HV3, DM1
<b>Control</b>	NULL, POLL, ID
<b>Bluetooth device address</b>	Valid range: 0000 0000 0000 to FFFF FFFF FFFF Hex
<b>Active member address</b>	Valid range: 0 to 7
<b>Payload data patterns</b>	0s, 1s, 01s, 10s, 8-bit pattern, PN9, PN15, user file
<b>Burst power ramp</b>	Power ramp valid range: 1 to 10 $\mu$ s Ramp settling valid range: 1 to 20 $\mu$ s (cannot be more than 10 $\mu$ s greater than the power ramp setting) Dirty transmitter test menu Power ramp valid range: 1 to 100 $\mu$ s Ramp settling valid range: 1 to 120 $\mu$ s (cannot be more than 20 $\mu$ s greater than the power ramp setting) Resolution: 1 $\mu$ s
<b>Impairments</b>	
<b>Frequency offset</b>	Valid range: -100 kHz to 100 kHz Dirty transmitter test valid range: -150 to 150 kHz Resolution: 1 kHz
<b>Frequency drift</b>	
Linear	Valid range: -100 kHz to 100 kHz Resolution: 1 kHz
Sinusoidal	Valid range: -100 kHz to 100 kHz Resolution: 1 kHz Rate: 300 Hz, 500 Hz, 1.6 kHz
<b>Modulation index</b>	Valid range: 0.250 to 0.400 Dirty transmitter test valid range: 0.200 to 0.400 Resolution: 0.001
<b>Symbol timing error</b>	Valid range: -50 ppm to 50 ppm Dirty transmitter test valid range: -150 ppm to 150 ppm Resolution: 1 ppm
<b>AWGN</b>	C/N valid range: 10 dB to 40 dB Resolution: 1 dB Seed valid range: 1 to 65535
<b>Clock and gate delay</b>	Valid range: 0 to 100 $\mu$ s Resolution: (1 $\mu$ s/oversampling ratio)
<b>Oversampling ratio</b>	Valid range: 2 to 20

<sup>1</sup> Features subject to change.

## ***Acronym List***

ACL	Asynchronous Connection-Less
ACP	Adjacent Channel Power
ADS	Advanced Design System
AM ADDR	Active Member Address
AWGN	Additive White Gaussian Noise
BD ADDR	<i>Bluetooth</i> Device Address
BER	Bit Error Rate
BT	Bandwidth Time product
CCDF	Complementary Cumulative Distribution Function
CRC	Cyclic Redundancy Check
DAC	Digital/Analog Converter
DUT	Device Under Test
dBm	Decibels relative to 1 milliwatt
FEC	Forward Error Correction
FHSS	Frequency Hopping Spread Spectrum
FSK	Frequency Shift Keying
GFSK	Gaussian Filtered Frequency Shift Keying
GPIB	General Purpose Interface Board
IF	Intermediate Frequency
I/Q	Inphase/Quadrature
ISM	Industrial, Scientific, and Medical
PC	Personal Computer
PN	Pseudorandom Noise
PN9	Pseudorandom Noise of period $2^9-1$
PN15	Pseudorandom Noise of period $2^{15}-1$
RF	Radio Frequency
SCO	Synchronous Connection-Oriented
SIG	Special Interest Group
TDD	Time-Division Duplex
TTL	Transistor-Transistor Logic
VSA	Vector Signal Analyzer

## ***Additional Literature***

## **Related Agilent literature**

---

*E4438C Signal Studio Installation Guide*

Available at: [www.agilent.com/find/signalstudio](http://www.agilent.com/find/signalstudio)

*E4438C ESG Vector Signal Generator - Data Sheet*

Literature number 5988-4039EN

*E4438C ESG Vector Signal Generator - Configuration Guide*

Literature number 5988-4085EN

*Measuring Bit Error Rate Using the ESG-D Series RF Signal Generators, Option UN7*

Literature number 5966-4097E

*Signal Studio for Bluetooth, E4438C ESG Vector Signal Generator, Option 406 - Technical Overview*

Literature number 5988-5458EN

*Bluetooth RF Measurement Fundamentals, Application Note 1333-1*

Literature number 5988-3760EN

*Bluetooth RF Testing – The Right Tests For The Radio, White Paper,*

[www.agilent.com/find/bluetooth](http://www.agilent.com/find/bluetooth)

*Verifying Bluetooth Baseband Signals Using Mixed-Signal Oscilloscopes, Application Note*

Literature number 5988-2181EN

*Investigating Bluetooth Modules: The First Step in Enabling Your Device with a Wireless Link, Application Note*

Literature number 5988-2417EN

*Agilent Technologies - Bluetooth Technology Portal,*

[www.agilent.com/find/bluetooth](http://www.agilent.com/find/bluetooth)

---

## **References**

---

*Specification of the Bluetooth System, Version 1.1*

*Bluetooth RF Test Specification, Version 1.1*

---

## Appendix

---

An example MATLAB® program to generate and save a user data file is shown below.

```
%***** Userdata File Example*****

% Set some constant parameters
numBytes = 16;
bitsPerByte = 8;

% Construct a bit stream
databits = ones(1,numBytes*bitsPerByte); % Sets entire stream to 1's
databits(11:2:29) = 0; % Set some alternating bits to 0's
databits(51:70) = 0; % Set a block of bits to 0's

% Convert from an array of bits to an array of bytes
databytes = ones(bitsPerByte, length(databits)/bitsPerByte); % Make array 8 x N/8
databytes(:) = databits; % Each column is 1 byte = 8 bits
c = [128 64 32 16 8 4 2 1]; % Weight according to bit position
data = c*databytes; % Change to decimal

fid = fopen('Userdata','w'); % Open a file named Userdata
fwrite(fid, data, 'uint8'); % Write the data to the file
fclose(fid); % Close the file

%*****
```

## Recommended configuration

---

E4438C ESG with the following options:

<b>E4438C-602*</b>	64 MSa baseband generator
<b>E4438C-406*</b>	Signal Studio for <i>Bluetooth</i>
<b>E4438C-503</b>	3 GHz frequency range
<b>E4438C-1E5</b>	High-stability timebase
<b>E4438C-005</b>	6 GB internal hard drive

\*Indicates required options. The baseband generator may be either Option E4438C-001, -002, -601, or -602..

### Try before you buy!

Go to [www.agilent.com/find/signalstudio](http://www.agilent.com/find/signalstudio) and download Signal Studio for *Bluetooth* software to your PC. Only the signal configuration and plotting capabilities of the software can be evaluated. A license key is required to load the waveforms created by the software into the ESG. The license key can be ordered through your sales engineer or local sales office, which can be found at [www.agilent.com/find/assist](http://www.agilent.com/find/assist).

---

## Upgrade kits

---

If you currently own an E4438C ESG vector signal generator and are interested in obtaining an upgrade kit only (license key), order: E4438CK and option E4438CK-406.

---

**Agilent Technologies' Test and Measurement Support, Services, and Assistance**

Agilent Technologies aims to maximize the value you receive, while minimizing your risk and problems. We strive to ensure that you get the test and measurement capabilities you paid for and obtain the support you need. Our extensive support resources and services can help you choose the right Agilent products for your applications and apply them successfully. Every instrument and system we sell has a global warranty. Support is available for at least five years beyond the production life of the product. Two concepts underlie Agilent's overall support policy: "Our Promise" and "Your Advantage."

**Our Promise**

Our Promise means your Agilent test and measurement equipment will meet its advertised performance and functionality. When you are choosing new equipment, we will help you with product information, including realistic performance specifications and practical recommendations from experienced test engineers. When you use Agilent equipment, we can verify that it works properly, help with product operation, and provide basic measurement assistance for the use of specified capabilities, at no extra cost upon request. Many self-help tools are available.

**Your Advantage**

Your Advantage means that Agilent offers a wide range of additional expert test and measurement services, which you can purchase according to your unique technical and business needs. Solve problems efficiently and gain a competitive edge by contracting with us for calibration, extra-cost upgrades, out-of-warranty repairs, and onsite education and training, as well as design, system integration, project management, and other professional engineering services. Experienced Agilent engineers and technicians worldwide can help you maximize your productivity, optimize the return on investment of your Agilent instruments and systems, and obtain dependable measurement accuracy for the life of those products.

**Agilent T&M Software and Connectivity**

Agilent's Test and Measurement software and connectivity products, solutions and developer network allows you to take time out of connecting your instruments to your computer with tools based on PC standards, so you can focus on your tasks, not on your connections. Visit [www.agilent.com/find/connectivity](http://www.agilent.com/find/connectivity) for more information.

**By internet, phone, or fax, get assistance with all your test & measurement needs**

**Phone or Fax**

**United States:**  
(tel) 800 452 4844

**Canada:**  
(tel) 877 894 4414  
(fax) 905 282 6495

**China:**  
(tel) 800 810 0189  
(fax) 800 820 2816

**Europe:**  
(tel) (31 20) 547 2323  
(fax) (31 20) 547 2390

**Japan:**  
(tel) (81) 426 56 7832  
(fax) (81) 426 56 7840

**Korea:**  
(tel) (82 2) 2004 5004  
(fax) (82 2) 2004 5115

**Latin America:**  
(tel) (305) 269 7500  
(fax) (305) 269 7599

**Taiwan:**  
(tel) 0800 047 866  
(fax) 0800 286 331

**Other Asia Pacific Countries:**  
(tel) (65) 6375 8100  
(fax) (65) 6836 0252

Email:  
tm\_asia@agilent.com

**Online Assistance:**

[www.agilent.com/find/assist](http://www.agilent.com/find/assist)

Product specifications and descriptions in this document subject to change without notice.

© Agilent Technologies, Inc. 2002, 2003  
Printed in USA, October 16, 2003  
5988-5417EN



**Agilent Email Updates**

[www.agilent.com/find/emailupdates](http://www.agilent.com/find/emailupdates)

Get the latest information on the products and applications you select.

*Bluetooth* and the *Bluetooth* logos are trademarks owned by *Bluetooth* SIG, Inc., U.S.A. and licensed to Agilent Technologies.

MATLAB® is a U.S. registered trademark of The Mathworks, Inc.

[www.agilent.com/find/esg](http://www.agilent.com/find/esg)



**Agilent Technologies**